

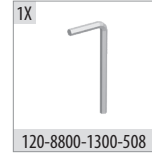

■ MULTILINE 2 1 Set İçeriği / 1 Set Includes

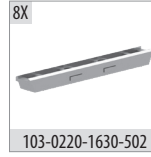

■ Ray Profilleri / Rail Profiles

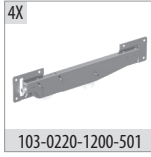
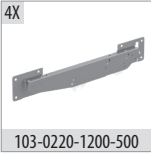
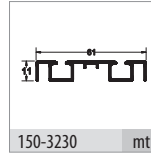
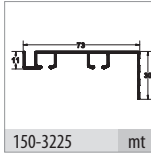
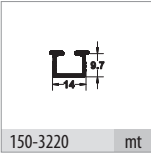

■ Kulp Profilleri / Handle Profiles

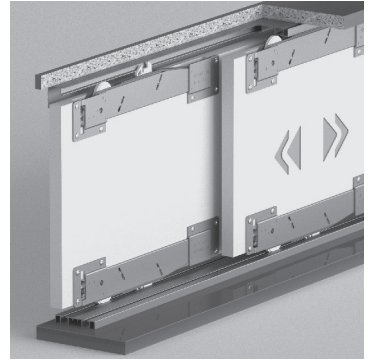
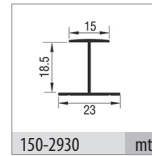
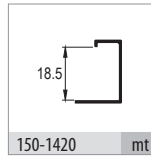
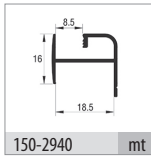
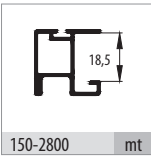

■ Ürün Özellikleri

- İçte çalışan alt taşıyıcılı sürme dolap sistemidir.
- Ahşap kapaklarda uygulanabilir.
- Taşıma Kapasitesi 1 kapak için 50 kg'dır.
- 16 - 30 mm kapak kalınlıklarında kullanıma uygundur.
- Ray içi fren sistemi ile açılış ve kapanış yönünde frenleme özelliğine sahiptir.
- 2 / 3 / 4 kapaklı uygulamalar yapılabilir.
- Yükseklik ayarlı alt mekanizmaya sahiptir.
- Yüksek kaliteli rulman sayesinde sessiz ve uzun ömürlü çalışma sağlar.
- Kolay ve pratik montaj imkanı sunar.
- Multiline 2, tek gövde içerisinde entegre mekanizma ve yavaşlatıcı sistemine sahiptir.
- Ofis ve dolap sistemleri için tercih edilebilir.
- Gömme alt üst ray profili tercihinin yanı sıra farklı ray profil alternatiflerine sahiptir.
- Sessiz çalışması ve yavaşlatıcı sistemi sayesinde yüksek kaliteli bir kullanıcı deneyimi sağlar.
- Sürgü Sistemin 3D kurulum montaj videosuna albaturas.com'dan ulaşabilirsiniz.

■ Product Properties

- It is a sliding cabinet system with inner working sub-carrier.
- Applicable on wooden covers.
- Carrying Capacity is 50 Kg for 1 cap.
- Suitable for use in 16 - 30 mm cover thicknesses.
- It has a braking feature in the opening and closing direction with its in-rail braking system.
- 2 / 3 / 4 cover applications can be made.
- It has a height-adjustable bottom mechanism.
- Provides quiet and long-lasting operation thanks to high-quality bearing.
- Provides easy and practical assembly.
- Multiline 2 has an integrated mechanism and retarder system in a single body.
- Can be preferred for office and cabinet systems.
- It has different rail profile alternatives as well as the choice of recessed lower and upper rail profile.
- It provides a high quality user experience thanks to its silent operation and deceleration system.
- You can reach the 3D installation video of the Sliding System at albaturas.com



* Verilen ölçüler bağlayıcı değildir. Önerilen kurulum ölçüleridir. Albatur ürün özelliklerinde haber vermeden değişiklik yapabilir.

* The given dimension are not binding. These are recommended asamble dimensions. Albatur can make alteration to product specification without notice.

