

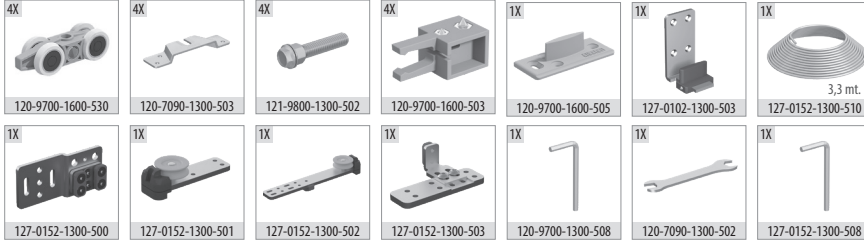

■ MultiDoor 152 1 Set İçeriği / 1 Set Includes

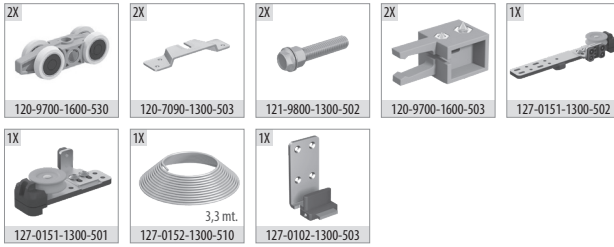

■ MultiDoor 151 1 Takım İçeriği (Opsiyonel Ek Kapa) / 1 Kit Includes (Optional Additional Door)



■ Ray Profilleri / Rail Profiles

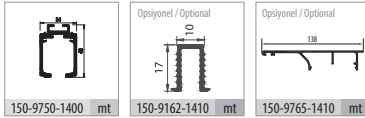

■ Bilgi / Information

- Minimum kapı genişliği 450 mm olmalıdır.
- Min. Door width 450 mm

■ Ürün Özellikleri

- MultiDoor 150 sürgülü teleskopik kapı sistemidir.
- Ahşap panel kapılar için tasarlanmıştır.
- Taşıma kapasitesi kapak başına 80 kg'dır.
- Halatlı sistem sayesinde kapılar senkronize çalışır.
- 30 - 50 mm panel kalınlıklarında kullanıma uygundur.
- Her kanat ayrı ray profilinde çalışır.
- İlave kapı seti sayesinde kanat sayısı artırılabilir.
- Yüksek kaliteli rulman sayesinde sessiz ve uzun ömürlü çalışma sağlar.
- Sistemde stoper mevcuttur.
- Estetik görünüm ve sağlıklı çalışma sistemine sahiptir.
- Kolay ve pratik montaj imkanı sunar.
- Minimum kapak genişliği 450 mm olmalıdır.
- Üst mekanizmaya yükseklik ayarı yapılabilir.
- Ray üzerine monte edilebilen opsiyonel kapama profili sayesinde mekanizma detaylarını gizler.

■ Product Properties

- MultiDoor 150 is a telescopic sliding door system
- Suitable for wooden panel doors
- Carrying capacity is 80 kg per door
- Due to the rope system, the doors work synchronously.
- Able to use assembly with 30 - 50 mm wood panel
- Each door runs on a separate rail profile
- Due to additional door set, the number of doors can be increased
- System is working silent and long life working because of high quality ball bearings
- System has plastic stopper
- Aesthetic appearance and healthy working system
- Easy and quick installation
- Minimum door width should be 450 mm
- Able to adjustment up and down
- It hides the mechanism details thanks to the optional closing profile that can be mounted on the rail.

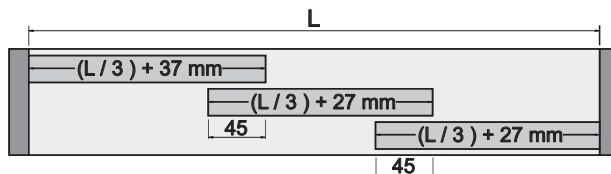
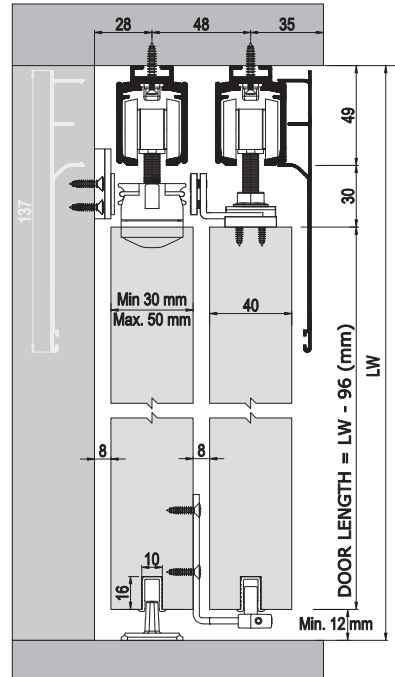
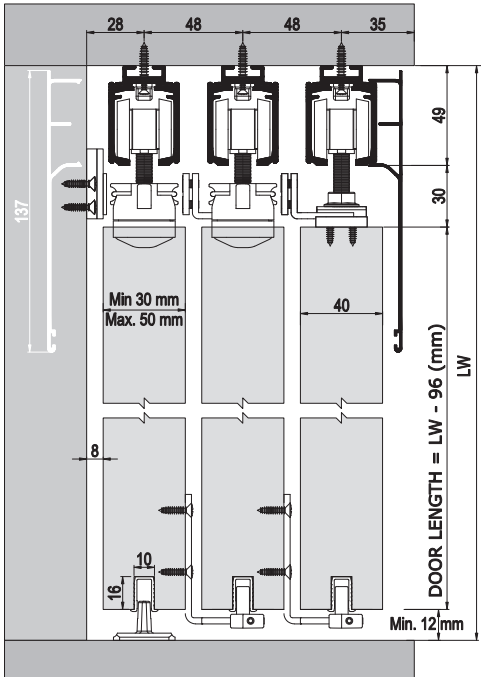
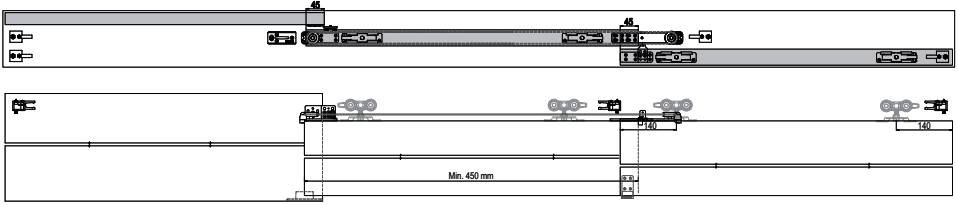

Ölçülerde değişiklik yapma hakkı saklıdır. Reserves the right to the change of the dimensions.